



Club Car DS (IQ and PD Plus) Mounting Adapter for the Alltrax XCT controllers

File: DOC113-011-C_CC-DS Univ Adapter Mount.pdf, Released Rev C, EC-07142016
ALLTRAX PN: KIT-UNIV-MNT-CC-DS (for IQ - NOT Precedent)

The XCT adapter provides a simple solution to mount the Alltrax XCT products without drilling holes or hardware. Hardware enclosed includes the ABS+PC plastic adapter, flat head SAE surface mount bolts (3) and the 4x bolts, nuts, and washers to mount the controller.

Steps:

1. Disconnect positive battery terminal.
2. Remove the old controller from the cart (retain all hardware if you wish to return the cart to OEM)

The stock controller shown may be the Curtis IQ controller or the 23 pin PD Plus with GE controller. Kit includes 4 screws:

- 3x used for IQ controller
- 4x used for GE controllers

NOTE: The wires polarity and mark Or color tape if necessary!

BLACK = B-
WHITE = Motor Minus
YELLOW = Battery Plus
GREEN = Motor Plus

(YEL + GRN will be on the B+ terminal)



3. Insert the 4 HEX NUTS (1/4-20 nuts) into the adapter as shown. The nuts are on the BACK SIDE of the mounting adapter plate. The Nyloc plastic faces out, press them flush with the surface. **If the nuts are loose, use scotch tape to hold them in place.** (Some hardware is tight, some may be loose...)

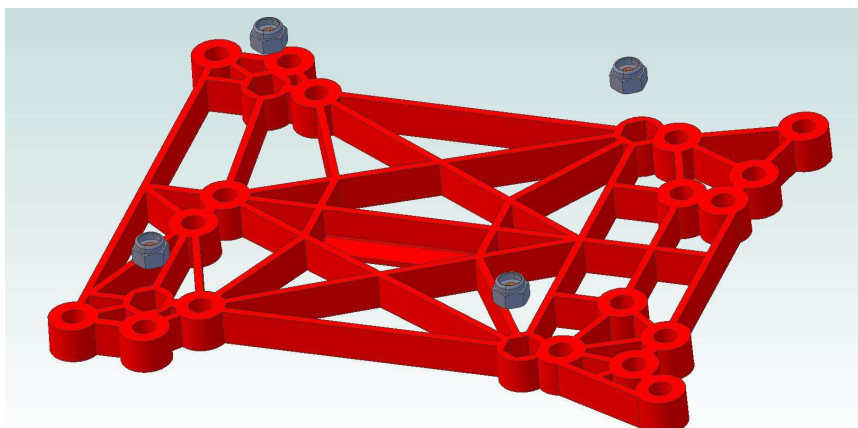

4. Install the adapter plate onto the golf cart mounting plate with the 4x NUTS "**against the carts mounting plate**". The ALLTRAX LOGO will be facing you upside down shown below so the wiring cable can properly connect to the controller. The 4X controller bolts holding the controller go "through the controller to adapter" into the nuts on the back side.
5. **USE Petroleum GREASE on the socket head FLAT CAP screws threads to prevent binding** (i.e. counter sunk screws). Install and tighten the 1/4"-20x1" FLAT HEAD CAP screws. Do not over tighten.

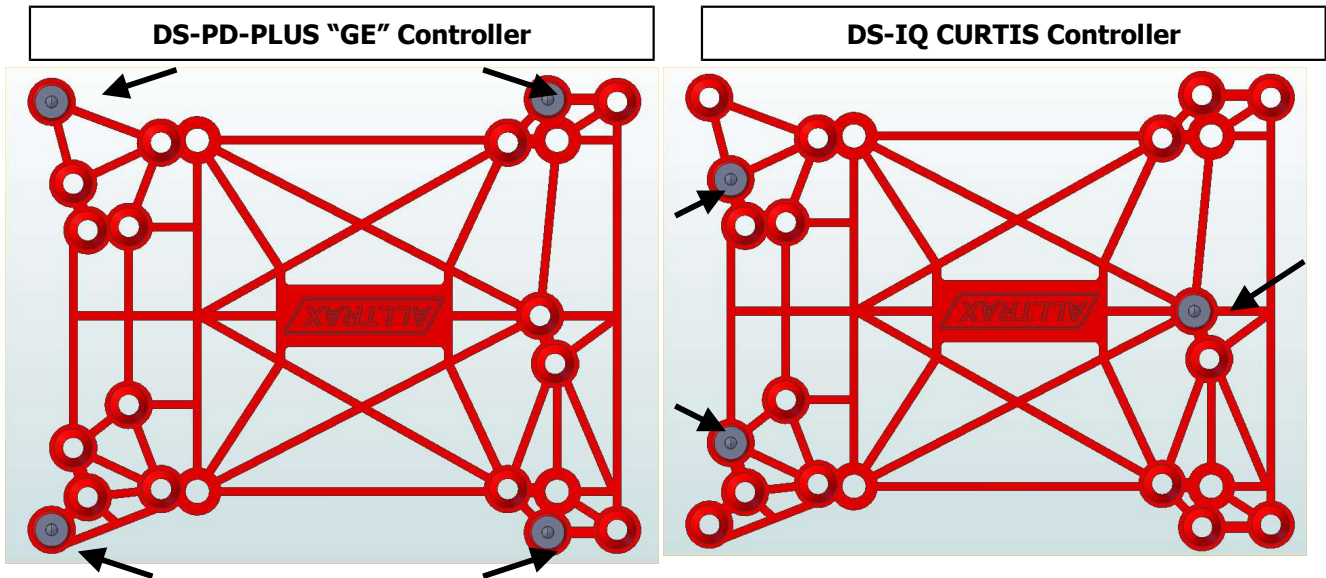

6. **Cover Clamp Relocation.** The Stock OEM cover L-bracket needs to be reversed and remounted to make room for the new controller. (Screws for IQ shown below but GE similar)



- 7. USE Petroleum GREASE on the 4X socket head cap bolt threads to prevent binding.** Mount the controller to the plate with the 4 mounting bolts, use the supplied small diameter flat washers on the bolts to protect the plastic controllers mount lugs. Do not over tighten bolts.

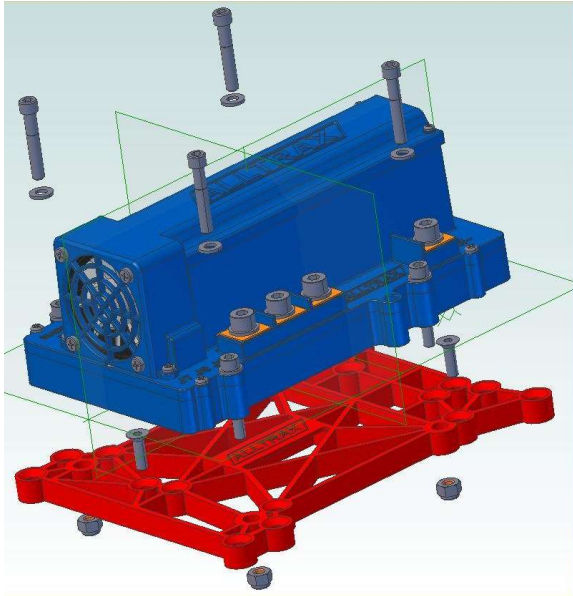

- 8. B- WIRE is SHORT.** The Battery Minus wire that passes through the OBC computer will be 1/2- to 1" short, install the supplied 250 or 400amp fuse in the Battery Minus lead to add enough wire length.



9. Using the supplied ring terminals, replace the field coil fast one terminals for the smaller 10AWG wires (BLK and GREEN) wires to the 5/16 ring terminals. Crimp using the appropriate crimper to ensure a solid connection. Connect the wires shown in the chart below.

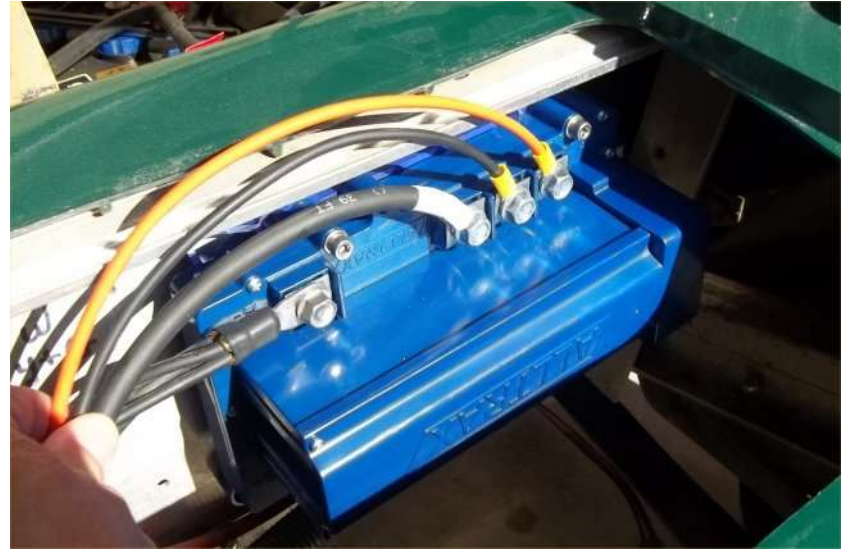
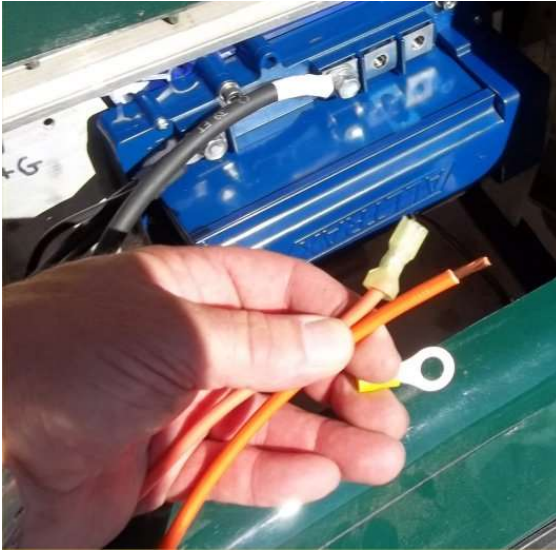

10. **The 16 pin control cable will be short.** Open the wire harness about 2-3 inches, install new zip ties or re-tape once the wire loom provides enough slack. In this example 2 inches of split loom were removed.

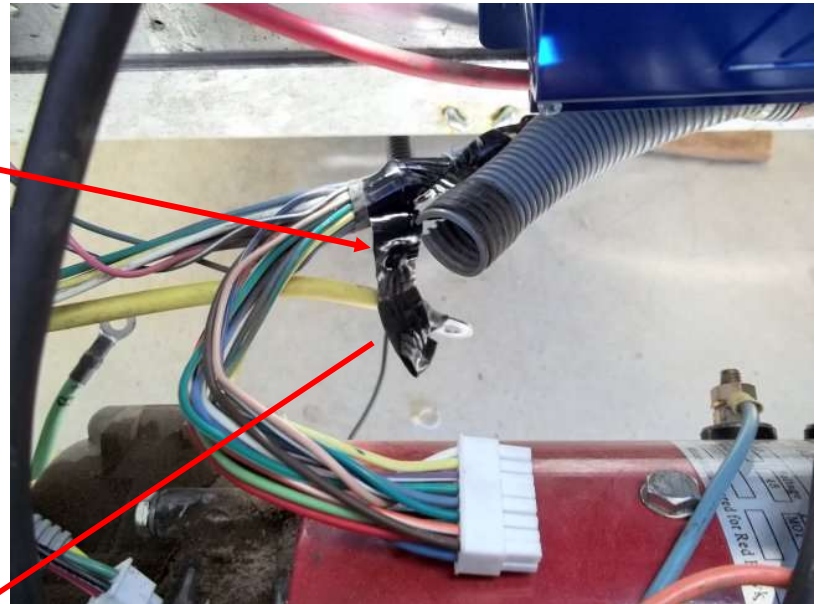
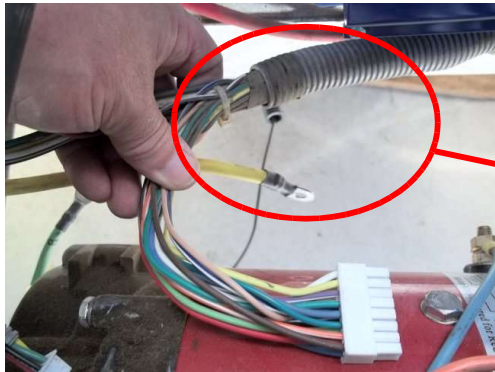

Terminal	Wire Color	Function
B+	2-Wires YEL+GRN	Battery + Motor Positive
B-	BLK	Battery Minus
J9, M-	WHT	Motor Negative
J8, F2	BLU-10AWG	Field coil
J7, F1	ORN-10AWG	Field coil